



USA SINCE 1936 | RELIABILITY BEYOND MEASURE

## Operating Manual

# *Amik 300 / 301*



---

The Information contained in these installation instructions is for use only by installers trained to make electrical power installations and is intended to describe the correct method of installation for this product. However, Company has no control over the field conditions which influence product installation.

It is the user's responsibility to determine the suitability of the installation method in the user's field conditions. Company only obligations are those in Company standard Conditions of Sale for this product and in no case will Company be liable for any other incidental, indirect or consequential damages arising from the use or misuse of the products.

---



# Three Phase (3W/4W)

## Three Phase Touch Screen Digital Multi-fuction Meter Installation & Operating Instructions

Section	Contents
1.	Introduction
2.	Measurement Reading Screens
3.	Programming
3.1	Password Protection
3.1.1	Change Password
3.2	Menu selection
3.2.1	System Parameter selection screen
3.2.1.1	System type
3.2.1.2	Potential transformer Primary value
3.2.1.3	Potential transformer Secondary value
3.2.1.4	Current transformer Primary value
3.2.1.5	Current transformer Secondary value
3.2.1.6	Demand integration time
3.2.1.7	Auto Scrolling
3.2.1.8	Low current noise cutoff
3.2.1.9	Energy On RS 485
3.2.1.10	Energy digit reset count
3.2.2	Communication Parameter selection screen
3.2.2	Address Setting
3.2.2.2	RS 485 Baud rate
3.2.2.3	RS 485 Parity selection

- 3.2.3 Reset Parameter selection screen
  - 3.2.3.1 Resetting Parameter
- 3.2.4 Output Option selection screen (menu)
  - 3.2.4.3 Parameter setting for Analog Output-1
  - 3.2.4.4 Parameter setting for Analog Output-2
- 3.2.5 Brightness & Contrast
- 4. Touch screen calibration.
- 5. Phase Rotation Error screen.
- 6. Run - Hour.
- 7. On - Hour.
- 8. Number of Interruption
- 9. Analog Output
  
- 11. RS 485 (Modbus) output
  - 11.1 User Assignable modbus Registers

12. Phaser Diagram
13. Installation
  - 13.1 EMC installation Requirements
  - 13.2 Case Dimensions and Panel Cut-out
  - 13.3 Wiring
  - 13.4 Auxiliary Supply
  - 13.5 Fusing
  - 13.6 Earth / Ground Connections
14. Connection Diagrams
15. Specification
16. Connection for Optional RS 485 / Analog Output

## 1. Introduction

This instrument is a panel mounted 96 x 96mm DIN Quadratic Digital metering system for the measurement of important electrical parameters like AC voltage, AC Current, Frequency, Power, Energy (Active / Reactive / Apparent). The instrument integrates accurate measurement of technology (All Voltage & Current measurement are True RMS up to 15th Harmonic) with 320x240 Pixels touch screen TFT LCD display.

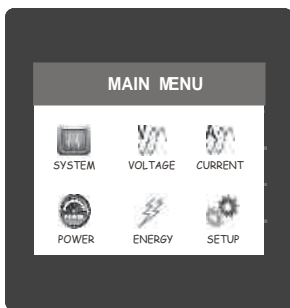

This instrument can be configured and programmed at site for the following:  
PT Primary, PT Secondary, CT Primary, CT Secondary (5A or 1A)  
and 3 phase 3W or 3 Phase 4W system.

The front panel has a 3.5" Touch Screen through which the user can move across the available measurement reading, reset the energy, Min/Max (System Voltage and System Current) and configure the product setting.

**TABLE 1:**

<b>Measured Parameters</b>	<b>Units of Measurement</b>
System Voltage	Volts
System Current	Amps
Voltage VL1-N(4wire only)	Volts
Voltage VL2-N(4wire only)	Volts
Voltage VL3-N(4wire only)	Volts
Voltage VL1-L2	Volts
Voltage VL2-L3	Volts
Voltage VL3-L1	Volts
Current L1	Amps
Current L2	Amps
Current L3	Amps
Neutral Current ( 4 wire only )	Amps
Frequency	Hz
Active Power (System / Phase (4 wire only) )	Kwatts
Reactive Power (System / Phase (4 wire only) )	KVAr
Apparent Power (System / Phase (4 wire only) )	KVA
Power Factor (System / Phase (4 wire only) )	—
Phase Angle ( Phase (4 wire only) )	Degree
Active Import Energy (8 Digit resolution)	kWh
Active Export Energy (8 Digit resolution)	kWh
Reactive Import Energy (8 Digit resolution)	kVArh
Reactive Export Energy (8 Digit resolution)	kVArh
Apparent Energy (8 Digit resolution)	kVAh
Ampere Hour (8 Digit resolution)	KAh

Measured Parameters	Units of Measurement
Current Demand	Amps
KVA Demand	KVA
KW Import Demand	KW
KW Export Demand	KW
Max Current Demand	Amps
Max kVA Demand	KVA
Max KW Import Demand	KW
Max KW Export Demand	KW
Run Hour	Hours
On Hour	Hours
Number of Interruptions	Counts
Phase Reversal Indication ( 4 wire only )	—
V1 THD*	%
V2 THD*	%
V3 THD*	%
I1 THD	%
I2 THD	%
I3 THD	%
System Voltage THD	%
System Current THD	%
Pictorial representation of Phaser Diagram (4 wire only)	—
Pictorial representation of Voltage Waveform	—
Pictorial representation of Current Waveform	—
Pictorial representation of VA Waveform per phase (4 wire only)	—

\*Note : THD Parameters are L-N in case of 3P 4W & L-L in case of 3P 3W .

## 2. Measurement Reading Screens

In normal operation the user is presented with one of the measurement reading screens out of several screens. These screens form particular submenu may be scrolled through one at a time in incremental order by touching the "➡ key" and in decremental order by touching "⬅ key" on that screen. Viewing of any individual parameter with large reading (eg. shown of Line to neutral Voltage L2 in sub menu 2 screen 13) is also possible by touching that particular parameter.

### SUBMENU 1: SYSTEM

Screen 1: System Parameters  
(System Voltage, System Current, System Active Power)

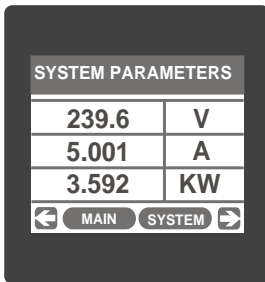

Screen 2: System Max. Values (System Voltage, System Current)

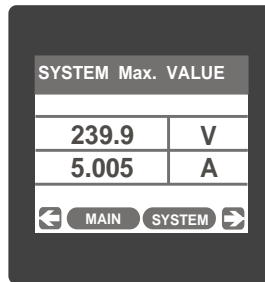

Screen 3: System Min. Values (System Voltage, System Current)

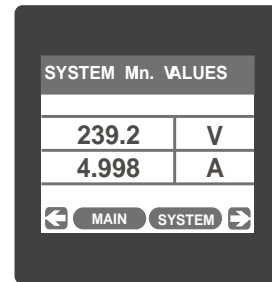

Screen 4: Pictorial Representation of Phasor Diagram (For 4 wire only)

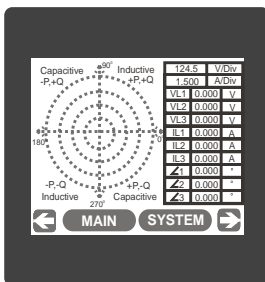

Screen 5 : System Run Hour

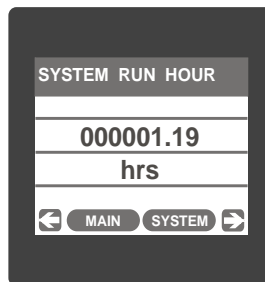

Screen 6 : System ON Hour

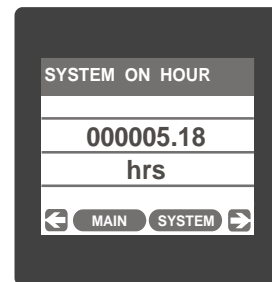



Screen 7 :  
System Interruptions

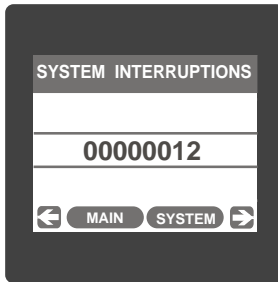

Screen 8 :  
System Frequency

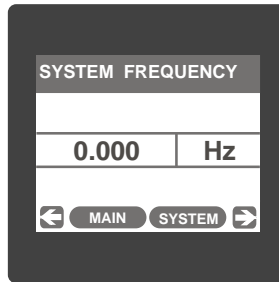

Screen 9 :  
System Power Factor

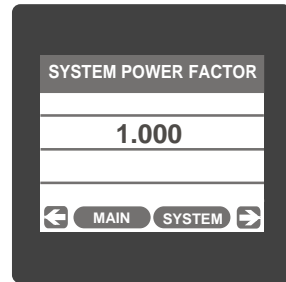

Screen 10 :  
System % THD

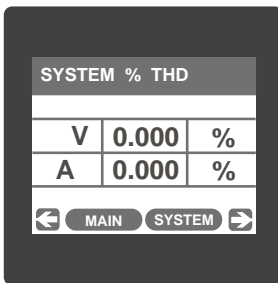

Screen 11 :  
System Power

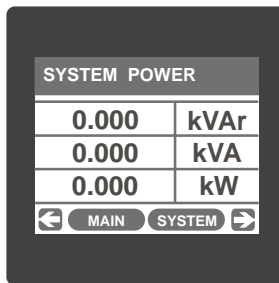

Screen 12 : Phase Sequence  
( 4 wire only ) Correct  
Phase Sequence

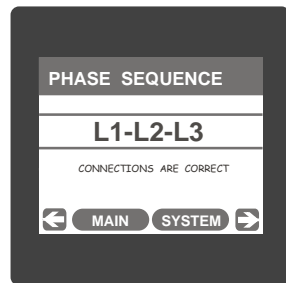

Phase Sequence Error

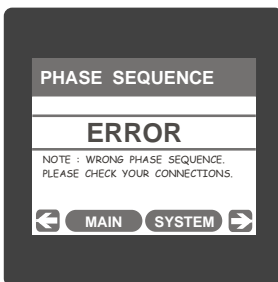

**SUBMENU 2 : VOLTAGE**  
Screen 13 : Line-Neutral Voltage  
(For 4 wire only)

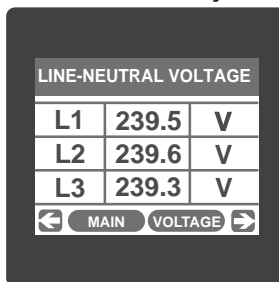

Phase L2 Line-Neutral Voltage  
(Displayed after touching any where  
in the L2 row shown in screen 13)

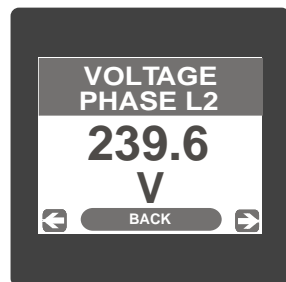

Screen 14 :  
Line-Line Voltage

LINE-LINE VOLTAGE		
L12	415.1	V
L23	414.9	V
L31	415.2	V

← MAIN VOLTAGE →

Screen 15 : Phase Voltage THD  
(In case of 4 wire)

PHASE VOLTAGE % THD		
L1	0.000	%
L2	0.000	%
L3	0.000	%

← MAIN VOLTAGE →

Screen 15 : Line Voltage THD  
(In case of 3 wire)

LINE VOLTAGE THD		
L12	0.000	%
L23	0.000	%
L31	0.000	%

← MAIN VOLTAGE →

Screen 16 : Pictorial representation  
of Voltage Waveform (Only accessed  
through voltage submenu list)

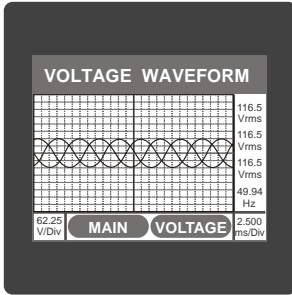

Screen 19:  
Line Current %THD

LINE CURRENT % THD		
IL1	0.000	%
IL2	0.000	%
IL3	0.000	%

← MAIN CURRENT →

**SUBMENU 3 : CURRENT**  
Screen 17 : Line Current

LINE CURRENT		
IL1	0.000	A
IL2	0.000	A
IL3	0.000	A

← MAIN CURRENT →

Screen 18 : Neutral Current  
(For 4 wire only)

NEUTRAL CURRENT		
In	0.000	A

← MAIN CURRENT →

Screen 20 : Pictorial representation  
of Current Waveform  
(Only accessed through  
current submenu list)

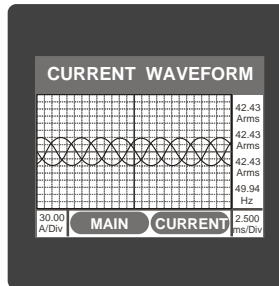

**SUBMENU 4 : POWER**  
Screen 21 : L1 Phase Power  
Reactive/Apparent/Active  
(For 4 wire only)

L1 PHASE POWER		
0.000	kVAr	
0.000	kVA	
0.000	kW	

← MAIN POWER →

Screen 22 : L2 Phase Power  
Reactive/Apparent/Active  
(For 4 wire only)

L2 PHASE POWER		
0.000	kVAr	
0.000	kVA	
0.000	kW	
← MAIN POWER →		

Screen 25 : Power Factor  
(Phase L1/L2/L3) (for 4W only)

POWER FACTOR		
L1	1.000	
L2	1.000	
L3	1.000	
← MAIN POWER →		

Screen 28 :  
Import Active Demand

IMPORT ACTIVE DEMAND		
Demand	0.000	kW
Max Demand	0.000	kW
← MAIN POWER →		

Screen 23 : L3 Phase Power  
Reactive/Apparent/Active  
(For 4 wire only)

L3 PHASE POWER		
0.000	kVAr	
0.000	kVA	
0.000	kW	
← MAIN POWER →		

Screen 26 :  
Current Demand

CURRENT DEMAND		
Demand	0.000	A
Max Demand	0.000	A
← MAIN POWER →		

Screen 29 :  
Export Active Demand

EXPORT ACTIVE DEMAND		
Demand	0.000	kW
Max Demand	0.000	kW
← MAIN POWER →		

Screen 24 : Phase Angle  
(Phase L1/L2/L3) (for 4W only)

PHASE ANGLE		
L1	0.000	DEG
L2	0.000	DEG
L3	0.000	DEG
← MAIN POWER →		

Screen 27 :  
VA Demand

VA DEMAND		
Demand	0.000	kVA
Max Demand	0.000	kVA
← MAIN POWER →		

Screen 30 : Pictorial representation  
of L1 Phase Waveform (For 4 wire only)  
(only accessed through power submenu list)

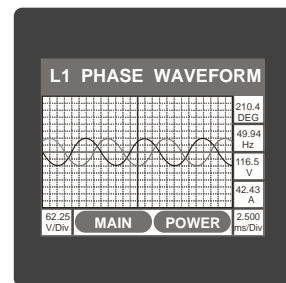

Screen 31 : Pictorial representation  
L2 Phase Waveform (For 4 wire only)  
(only accessed through power submenu list)

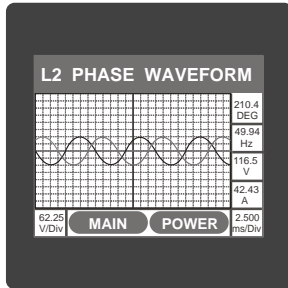

Screen 34 :  
Active Energy Export

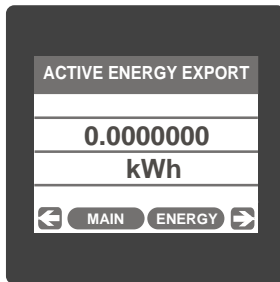

Screen 37 :  
Apparent Energy

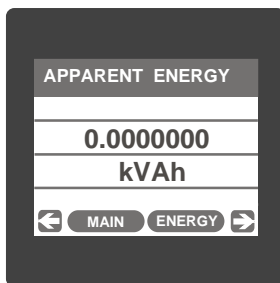

Screen 32 : Pictorial representation  
L3 Phase Waveform (For 4 wire only)  
(only accessed through power submenu list)

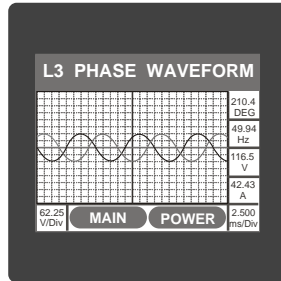

Screen 35 :  
Reactive Energy Import

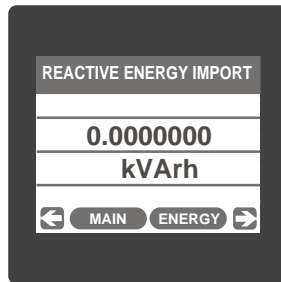

Screen 38 :  
Ampere Hour

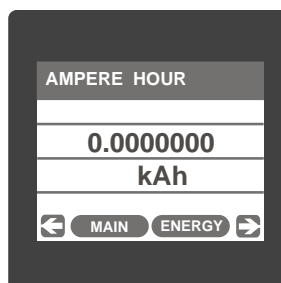

## SUBMENU 5 : ENERGY

Screen 33 :  
Active Energy Import

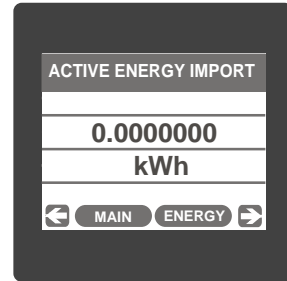

Screen 36 :  
Reactive Energy Export

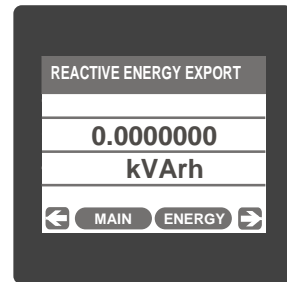

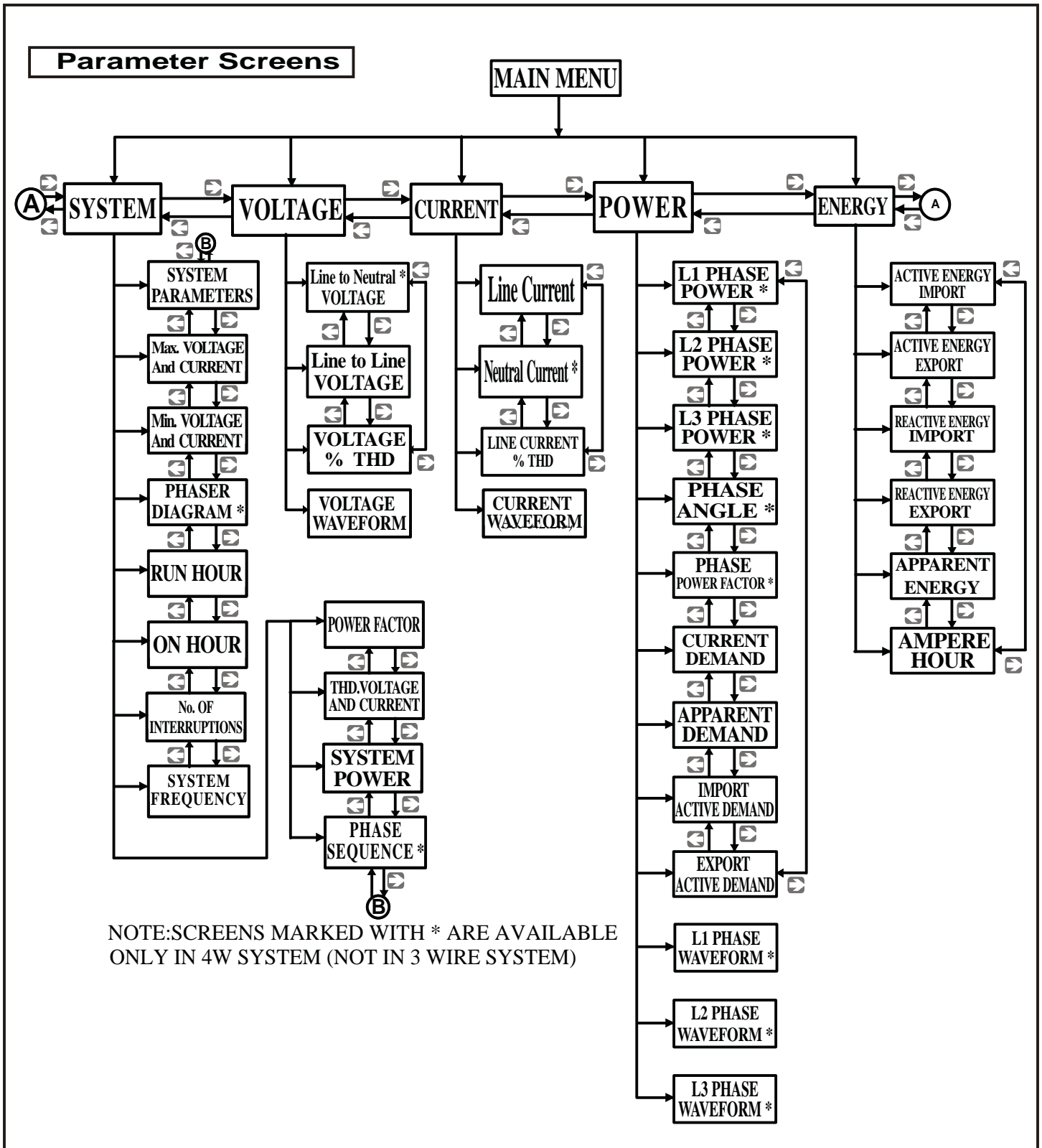

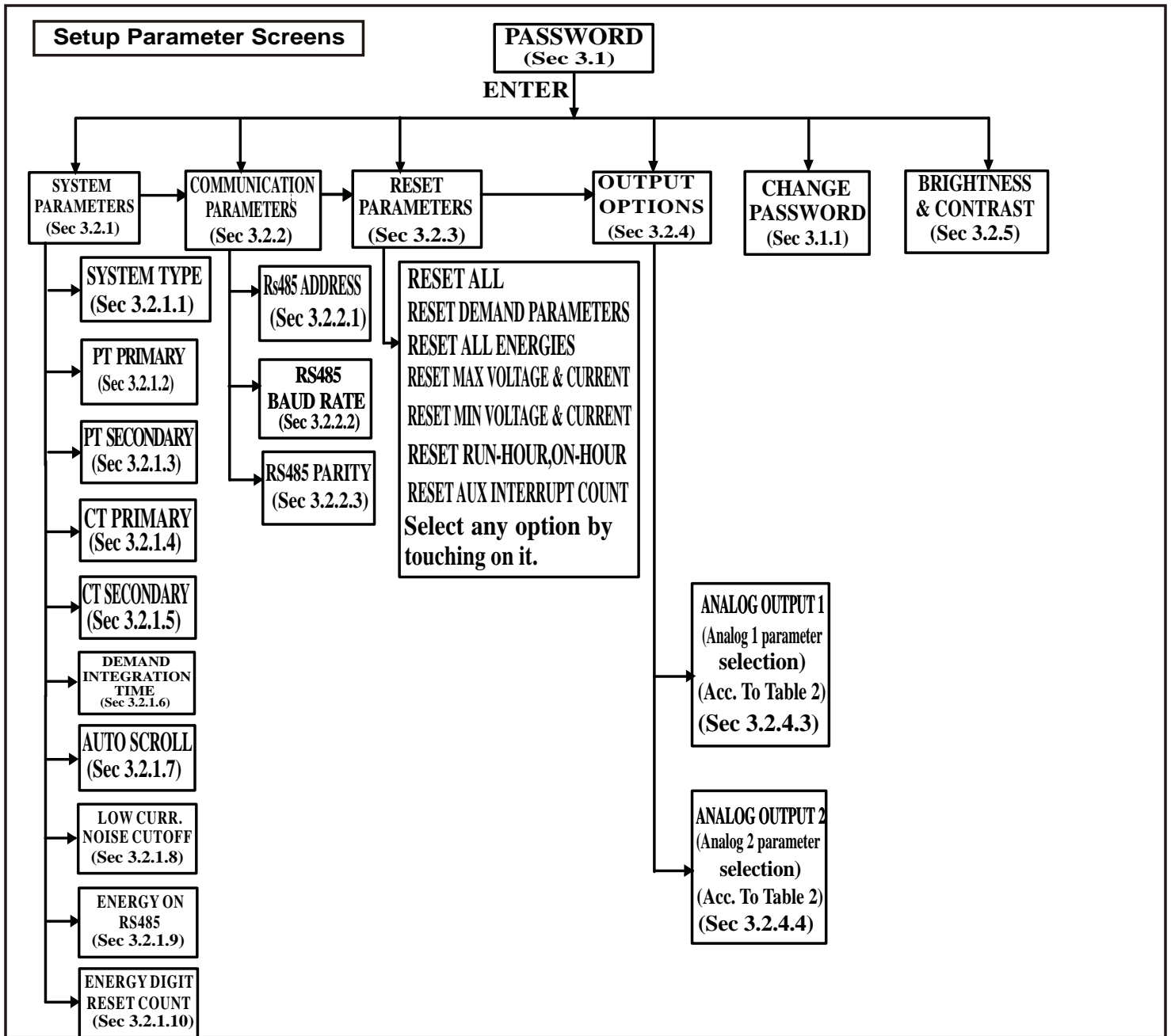

### 3. Programming

The following sections comprise step by step procedures for configuring the instrument for individual user requirements.

To access the set-up screens touch on the "  SETUP " icon in Main Menu. This will take the User into the Password Protection Stage(Section 3.1).

#### 3.1. Password Protection

Password protection can be enabled to prevent unauthorised access to set-up screens, by default password is "0000".

Password protection is enable by selecting any four digit number.



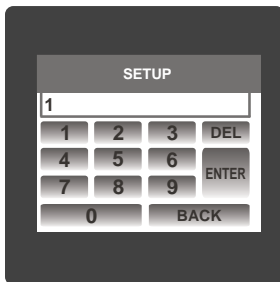

After touching "  SETUP" icon Password protection screen is displayed. Screen consists of 0 to 9 digit input keypad for entering the password very similar to any calculator in touchscreen mobile. "Enter Password" is displayed on screen at start so that user can enter password using displayed keypad.

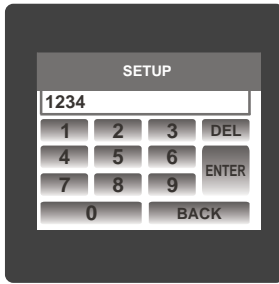

Touching "  key " will display 1 in display area, similiary user can enter remaining 3 digits.

For deleting any digit while entering password, user can touch "  key".



After entering the complete password user needs to confirm password by touching “ key”.

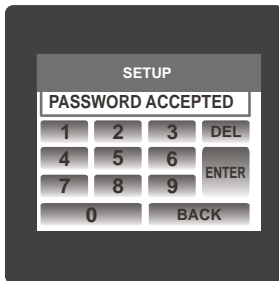

### Password confirmed.

If Entered password is correct then “Password Accepted” is displayed on screen & user will enter into setup menu.

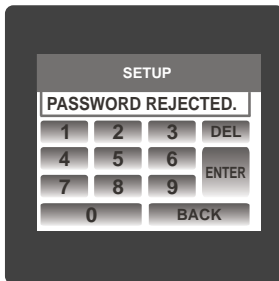

### Password Incorrect.

If Entered password is wrong then “Password Rejected” is displayed on screen & user need to re-enter the password



After wrong password is entered, user needs to touch “ key” for trying another password.



### 3.1.1 Change Password



Change Password Option is the second last option in list of "SETUP" submenu, so can be accessed by a simple touch anywhere in "Change Password" row.

In this screen user first need to enter the current password.

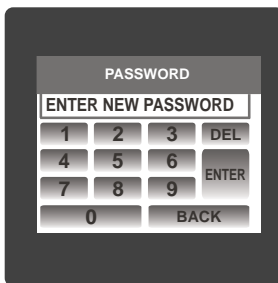

After input of correct password,"PASSWORD ACCEPTED"is displayed & now user can enter the new 4 digit password.



**New Password confirmed.**

After entering new password user needs to touch "ENTER key" to confirm.



After confirming "PASSWORD CHANGED" is displayed on screen, which ensures successful changing of the password.

### 3.2 Menu selection.

After entering in the SUBMENU 6 - SETUP, user will be asked to enter password & after input of correct password list of following parameters will be displayed on screen :-

3.2.1 SYSTEM PARAMETERS

3.2.2 COMMUNICATION PARAMETERS

### 3.2.3 RESET PARAMETERS

### 3.2.4 OUTPUT OPTIONS

### 3.2.5 BRIGHTNESS & CONTRAST

Touching on SYSTEM PARAMETER will open the system parameters list screen. Then these screens from particular parameter may be scrolled through one at a time in incremental order by touching the "➡ key" and in decremental order by touching "⬅ key" on given touch screen.

## 3.2.1 System Parameters Selection

After entering in the "SYSTEM PARAMETERS", List of following parameters will be display :-

### 3.2.1.1 SYSTEM TYPE

#### 3.2.1.2 PT PRIMARY(L-L)

#### 3.2.1.3 PT SECONDARY(L-L)

#### 3.2.1.4 CT PRIMARY

#### 3.2.1.5 CT SECONDARY

#### 3.2.1.6 DEMAND INTEGRATION TIME

#### 3.2.1.7 AUTO SCROLL

#### 3.2.1.8 LOW CURRENT NOISE CUTOFF

#### 3.2.1.9 ENERGY ON RS485

#### 3.2.1.10 ENERGY DIGIT RESET COUNT

### 3.2.1.1 System Type

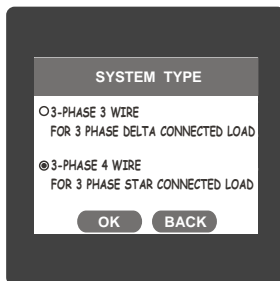

This screen is used to set the system type.

Two types: 3 phase 3 wire & 3 phase 4 wire system are displayed on screen. Touching radio button in front of particular type will select that type.

Touch on " **OK** " key" will confirm the system type.

Touching the " **BACK** " key" will keep the old selected setting and will return to previous menu.

Note : If system type is changed, relay parameter selection & analog output selection will be set to NONE.

### 3.2.1.2 Potential Transformer Primary Value

The nominal full scale voltage will be displayed as Line to Line Voltages for all system types.

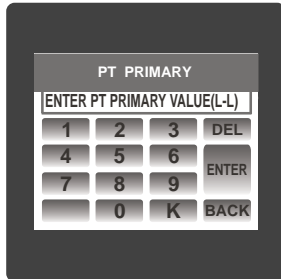

This screen can be accessed only from system parameters list menu. Here again 0 to 9 digit input keypad is provided to set value of PT Primary, & user can confirm this value with a simple touch "ENTER" key". "K" key" is used to multiply value by 1000.

In case presently displayed Potential Transformer Primary value together with the Current Transformer Primary value, previously set, would result in a maximum power of greater than 666.6 MVA per phase, "Invalid value" will be displayed. Then the valid range will be displayed.

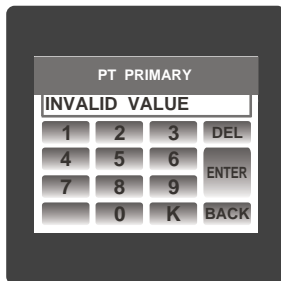

Valid range of PT primary setting value is from **100 VL-L to 692.8 KVL-L.**

If value outside the range is entered, It will display "INVALID VALUE" followed by correct range of parameter

### 3.2.1.3 Potential Transformer secondary Value

The value must be set to the nominal full scale secondary voltage which will be obtained from the the Transformer when the potential transformer(PT)primary is supplied with the voltage defined in 3.2.1.2 potential transformer primary voltage. The ratio of full scale primary to full scale secondary is defined as the transformer ratio.

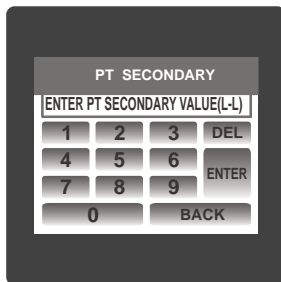

This screen can be accessed only from system parameters list menu. Here again 0 to 9 digit input keypad is provided to set value of PT Secondary, & user can confirm this value with a simple touch on "ENTER" key".

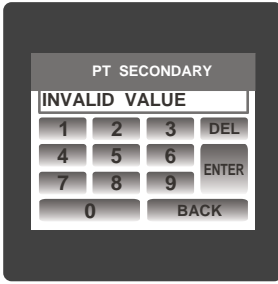

Valid range of PT secondary setting value is from 241.0 to 480.0 for 415 VL-L. Please refer the table bellow for different ranges. If value outside the range is entered, It will display "INVALID VALUE" followed by correct range of parameter

### Potential Transformer secondary ranges for various Input Voltages

110V L-L (63.5V L-N)	100 - 120V L-L (57.73V - 69.28V L-N)
230V L-L (133.0V L-N)	121 - 240V L-L (69.86V - 138.56V L-N)
415V L-L (239.6V L-N)	241 - 480V L-L (139.14V - 277.12V L-N)

### 3.2.1.4 Current Transformer Primary Value

The nominal Full Scale Current that will be displayed as the Line currents. This screen enables the user to display the Line currents inclusive of any transformer ratios, the values displayed represent the Current in Amps.

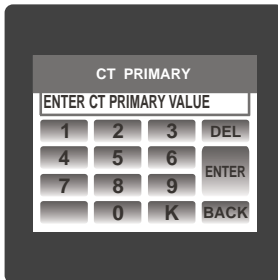

This screen can be accessed only from system parameters list menu.

Here again 0 to 9 digit input keypad is provided to set value of CT Primary & user can confirm this value with a simple touch on "ENTER" key. "K" key is used to multiply value by 1000.

In case presently displayed Current Transformer Primary Value together with the Potential Transformer Primary Value results in a maximum power of greater than 666.6 MVA, "invalid value" will be displayed. Example: If primary value of PT is set as 692.8kV L-L (max value) then primary value of Current is restricted to 1157A.

The "Maximum Power" restriction of 666.6 MVA refers to 120% of nominal current and 120% of nominal voltage, i.e, 462.96 MVA nominal power per phase.

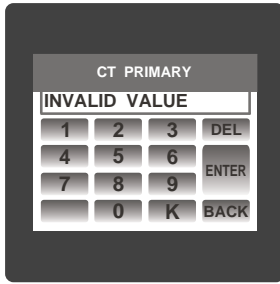

Valid range of CT primary setting value is from 1 to 9999. If value outside the range is entered, It will display "INVALID VALUE" followed by correct range of parameter

### 3.2.1.5 Current Transformer Secondary Value

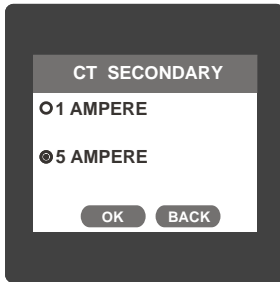

This screen is used to set the secondary value for Current Transformer. Two options: 1 AMPERE & 5 AMPERE are displayed on screen. Touching radio button in front of particular option will select that option.

Touch on " **OK** " key" will confirm the setting. Touching the " **BACK** " key" will keep the old selected setting and will return to previous menu.

### 3.2.1.6 Demand Integration Time

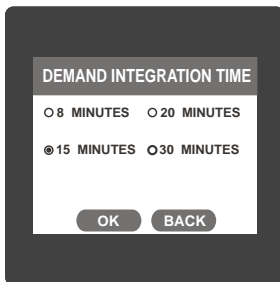

This screen is used to set the period over which current and power readings are to be integrated.

Four options: 8, 15, 20, 30 Minutes are displayed on screen. Touching radio button in front of particular option will select that option. Touch on " **OK** " key" will confirm the setting.

Touching the " **BACK** " key" will keep the old selected setting and will return to previous menu.

### 3.2.1.7 Auto Scrolling

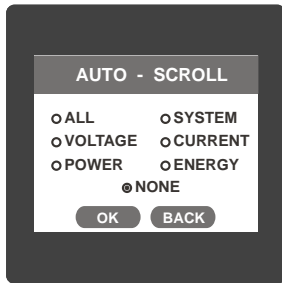

This screen allows user to enable screen scrolling. Seven options : ALL, SYSTEM, VOLTAGE, CURRENT POWER ENERGY & NONE are displayed on screen. Touching radio button in front of particular option will select that option. Selecting particular option means, only screen which are under that submenu will be scrolled automatically. Selecting NONE will disable Auto-Scroll.

Touch on " **OK** " key" will confirm the setting.

Touching the " **BACK** " key" will keep the old selected setting and will return to previous menu.

While in Auto-scrolling mode, touch sense for entire screen will be disabled except for the top right most corner where "A" symbol would be displayed stating that meter is in Auto-scroll mode.

Touching on "A" will show two options "ON" and "OFF". Touching on "ON" will continue auto scrolling & touching on "OFF" will stop auto-scrolling & return to normal mode.

### 3.2.1.8 Low Current noise cutoff.

This screen allows the user to set Low noise current cutoff in mA.

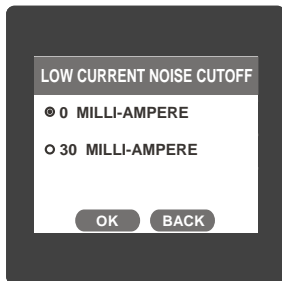

Two options, 0 MILLI-AMPERE & 30 MILLI-AMPERE are displayed on screen. Touching radio button in front of particular option will select that option.

Touch on " **OK** " key" will confirm the setting.

Touching the " **BACK** " key" will keep the old selected setting and will return to previous menu.

### 3.2.1.9 ENERGY ON RS485.

This screen enable user to set energy in terms of Wh / kWh / MWh on Rs485 Output depending as per the user's requirement .This setting is applicable for all types of energy.

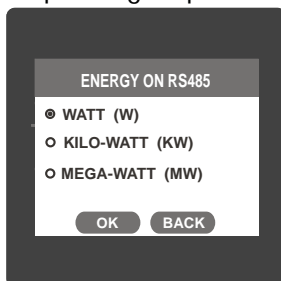

Three options: WATT, KILO-WATT & MEGA-WATT are displayed on screen. Touching radio button in front of particular option will select that option.

Touch on " **OK** " key" will confirm the setting.

Touching the " **BACK** " key" will keep the old selected setting and will return to previous menu.

**Note : Default value is set to 'WATT' i.e. Energy on Modbus will be in terms of Wh/VArh/VAh/Ah respectively.**

### 3.2.1.10 ENERGY DIGIT RESET COUNT (ROLLOVER COUNT)

This screen enables the user for setting maximum energy count after which energy will rollover to zero depending on the setting of Wh, kWh & Mwh in Energy on RS485 option.

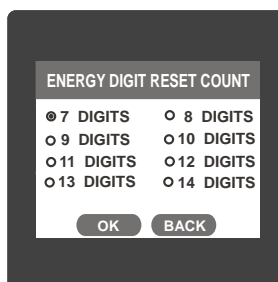

If Energy on RS485 is in WATT then rollover count can be from 7 to 14 DIGITS.

If Energy on RS485 is in KILO-WATT then rollover count can be from 7 to 12 DIGITS.

If Energy on RS485 is in MEGA-WATT then rollover count can be from 7 to 9 DIGITS.

Touching radio button in front of particular option will select that option.

Touch on " **OK** " key" will confirm the setting.

Touching the " **BACK** " key" will keep the old selected setting and will return to previous menu.

**Note :**

- 1) Default value of energy digit reset count is set to "14" i.e. if energy cross the 14 digit count it will rollover to zero.
- 2) If Energy on RS485 is set to kW & energy digit reset count is set to 12, Energy screen on display will show "-----" i.e. energy overflow when energy cross the 11 digit count.
- 3) If Energy on RS485 is set to MW & energy digit reset count is set to 9, Energy screen on display will show "-----" i.e. energy overflow when energy cross the 8 digit count.

## 3.2.2 Communication Parameter Selection :

After entering in the "COMMUNICATION PARAMETERS" list of following parameters will be displayed

- 3.2.2.1 RS485 ADDRESS
- 3.2.2.2 RS485 BAUD RATE
- 3.2.2.3 RS485 PARITY

### 3.2.2.1 RS485 Address Setting



This screen applies to the RS 485 output only. This screen allows the user to set RS485 address parameter for the instrument.

This screen can be accessed only from Communication Parameters List menu.

Here again 0 to 9 digit input keypad is provided to set RS485 address & user can confirm this value with a simple touch on "  key".



The range of allowable address is 1 to 247.

If value outside the range is entered, it will display "INVALID VALUE" followed by the correct range of parameter.

### 3.2.2.2 RS485 Baud Rate

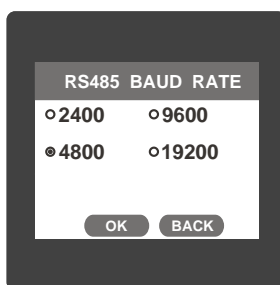

This screen allows the user to set Baud Rate of RS 485 port. Four options: 2400, 4800, 9600, 19200 Bauds are displayed on screen. Touching radio button in front of particular option will select that option.

Touch on "  key" will confirm the setting.

Touching the "  key" will keep the old selected setting and will Return to previous menu.



### 3.2.2.3 RS485 Parity & Stop bit Selection



This screen allows the user to set Parity & number of stop bits. Four options: ODD PARITY WITH ONE STOP BIT, NO PARITY WITH ONE STOP BIT, NO PARITY WITH TWO STOP BITS, EVEN PARITY WITH ONE STOP BIT are displayed on screen. Touching radio button in front of particular option will select that option.

Touch on " **OK** " key" will confirm the setting.

Touching the " **BACK** " key" will keep the old selected setting and will return to previous menu.

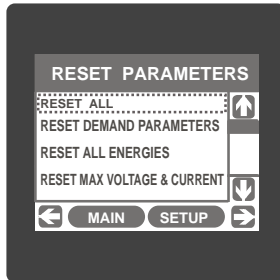

## 3.2.3 Reset Parameter Selection

### 3.2.3.1 Resetting Parameter

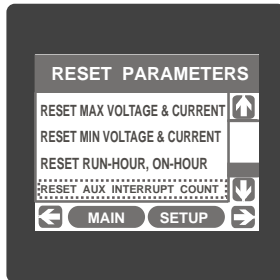

These screens allow the users to reset all the parameters eg;- Energy, Min, Max, Demand, Run hour, On hour, No. of Interrupts. Touching "  " key scrolls list in upward direction.



This screen is displayed after repeatedly touching "  " key. Touching "  " Up" key scrolls list in downward direction. For resetting specific parameter user can touch on that parameter.

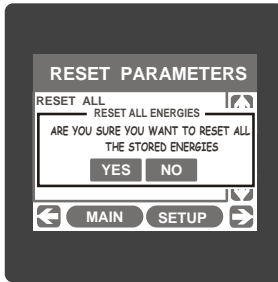

Touching on any parameter will display the confirmation dialog, now a touch on “ **YES** ” key” will confirm the resetting of that particular Parameter.

Touching on “ **NO** ” key” will move back to Reset parameters menu For example resetting All Energies will display a confirmation dialog as shown in the screen beside.

User can reset other parameters in similar manner.

### 3.2.4. Output Option selection menu

After entering in the “OUTPUT OPTIONS”, List of following parameters will be displayed :-

3.2.4.3 ANALOG-1 ( Model 301 only)

3.2.4.4 ANALOG-2 ( Model 301 only)

#### 3.2.4.3 Parameter setting for Analog Output 1 ( Only on Model 301 )

This option allows the user to set analog output 1 to corresponding measured parameter. A simple touch on “ANALOG-1” row will open screen having list of parameters.( Refer Table 2 “Parameter fo Analog output”)

Touch on “ **OK** ” key” will confirm setting.

Touching the “ **BACK** ” key” will keep the old selected setting and will return to previous menu.

#### 3.2.4.4 Parameter setting for Analog Output 2 ( Only on Model 301 )

This option allows the user to set analog output 2 to corresponding measured parameter. A simple touch on “ANALOG-2” row will open screen having list of parameters.( Refer Table 2 “Parameter fo Analog output”)

Touch on “ **OK** ” key” will confirm setting.

Touching the “ **BACK** ” key” will keep the old selected setting and will return to previous menu.

Parameter No.	Parameter	3P 4W	3P 3W	Range	
				Analog Output	
51	VA DEMAND	✓	✓	0 - 120 %	
52	VA MAX DEMAND	✓	✓	0 - 120 %	
53	CURRENT DEMAND	✓	✓	0 - 100 %	
54	CURRENT MAX DEMAND	✓	✓	0 - 100 %	
101	INPUT VOLTAGE L12	✓	✗	0 - 100 %	
102	INPUT VOLTAGE L23	✓	✗	0 - 100 %	
103	INPUT VOLTAGE L31	✓	✗	0 - 100 %	
113	NEUTRAL CURRENT	✓	✗	0 - 100 %	

**Note :** Parameters 1,2,3 are L-N Voltage for 3P 4W & L-L Voltage for 3P 3W .

(1) For Frequency 0% corresponds to 40 Hz & 100% corresponds to 70 Hz.

### 3.2.5 Brightness & Contrast



The brightness & contrast of the TFT LCD screen can be varied by the user by sliding the sliders. Touching the "OK" key will confirm the current brightness contrast setting.

Touching the DEFAULT key will set brightness and contrast as per factory setting. Touching the BACK key will move back to the setup menu without making any changes.

## 4 Touch screen calibration

This instrument is able to perform calibration to ensure the proper operation of the units touch screen functionalities. The calibration procedure will correct the problem of out of tolerance touch screen malfunction. Note that errors corrected by this calibration procedure are specific only to touch screen operation.

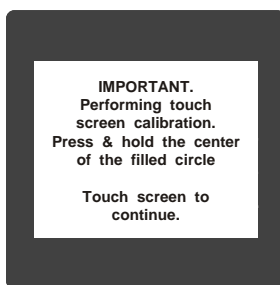

For starting touch screen calibration, touch the screen any where for 1 sec at system reset. After that touch screen calibration will start & the message shown besides will be displayed. Touch the screen to continue.

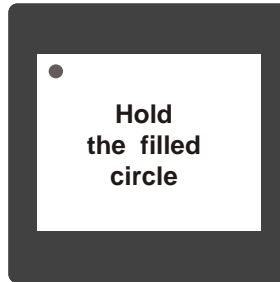
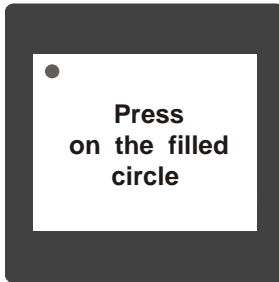

Follow the instructions displayed. Press & hold the center of the filled red circle for at least 2 seconds. Release when message for release is being displayed. For accurate results try to touch the center of the filled circle.

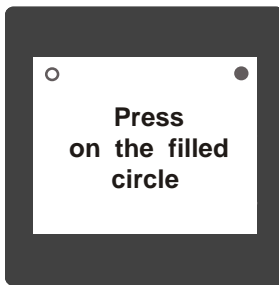

Repeat the same procedure for the remaining 3 corner circles.

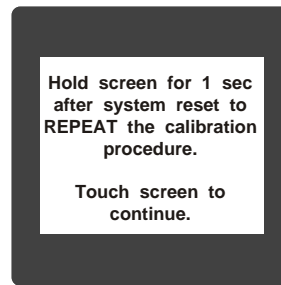

After successful calibration, the message shown besides would be displayed. Touch the screen to continue.

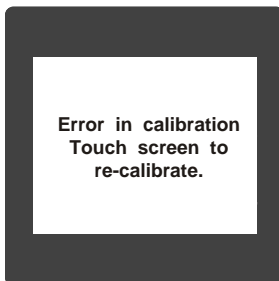

If the touch screen was not calibrated properly, "Error in calibration" message would be shown & the user will be asked to recalibrate the touch screen. In such case the meter will retain the previously stored touch - screen calibration values unless a successful calibration is being performed.



## 5. Phase Rotation Error screen

Meter shows phase rotation error if the phase sequence R-Y-B (L1-L2-L3) is not maintained. This screen indicates that Phase sequence is incorrect. User must check this screen in order to get correct readings when meter is connected.

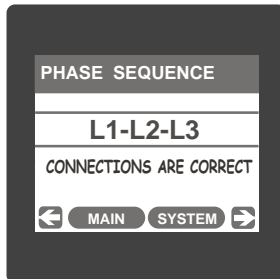

## Correct Phase sequence

This Screen indicates the phase sequence connected to meter is correct. If phase sequence is wrong this screen is useful to get correct phase sequence by interchanging connection & verifying it with screen.

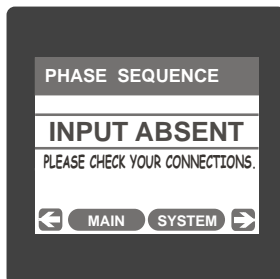

This Screen indicates that either of the phases or all three phases (Voltages) are absent.

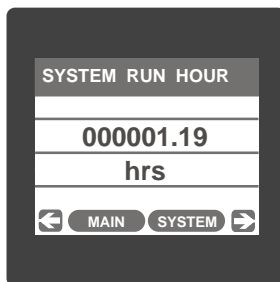

## 6. Run Hour

This Screen shows the total no. of hours the load is connected. Even if the Auxiliary supply is interrupted count of Run hour will be maintained in internal memory & displayed in the format “hours. min”. For example if Displayed count is 000001.19 hrs it indicates 1 hour & 19 minutes.

After 999999.59 run hours display restart from zero.

To reset run hour manually see section Resetting Parameter 3.2.3.1

## 7. On Hour

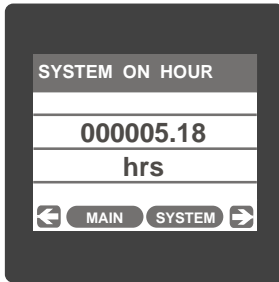

This Screen shows the total no. of hours the Axillary Supply is ON. Even if the Auxiliary supply is interrupted count of On hour will be maintained in internal memory & displayed in format “hours. min.” For example if Displayed count is 000005.18 hrs it indicates 15 hours & 18 minutes.

After 999999.59 On hours display will restart from zero.

To reset On hour manually see section Resetting Parameter 3.2.3.1

## 8. Number of Interruption

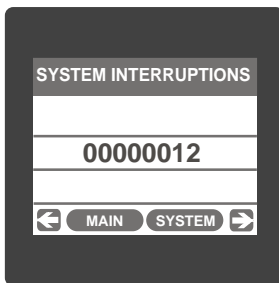

This Screen Displays the total no. of times the Axillary Supply was Interrupted. Even if the Auxiliary supply is interrupted count will be maintained in internal memory

To reset No of Interruption manually see section Resetting Parameter 3.2.3.1

## 9. Analog Output ( optional ) :

This module provides two d.c. isolated outputs .There are two output options

1) Two 4 - 20mA outputs , internally powered .

On both modules the output signals are present on pins A1(Analog Output 1) & A2 (Analog Output 2)

These outputs can be individually assigned to represent any one of the measured and displayed Parameters.

All settings are user configurable via the user interface screen. See Analog o/p selection ( section 3.2.4.3 & section 3.2.4.4 ) for details .

\* Note : Refer diagrams 1

Diagram 1 : ( 4 -20 mA )

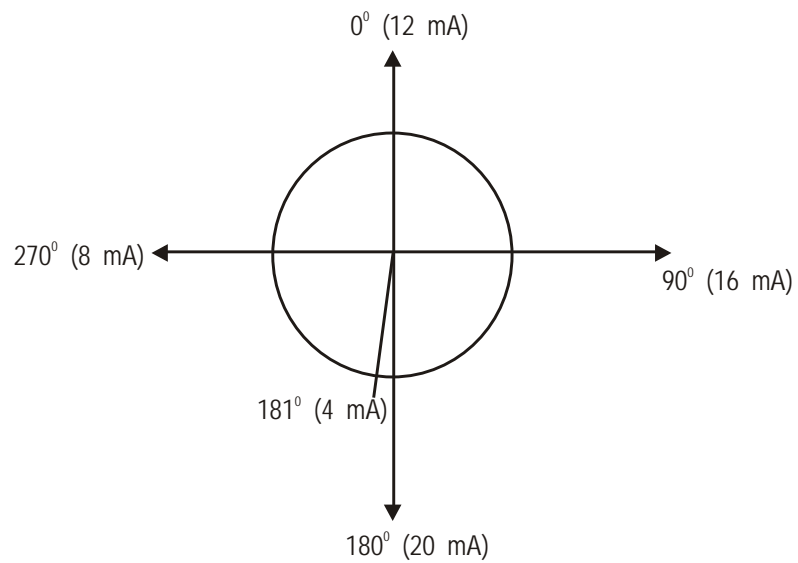

**TABLE 2 : Parameter for Analog**

Parameter No.	Parameter	3P 4W	3P 3W	Range	
				Analog Output	
0	None	✓	✓	-	
1	INPUT VOLTAGE L1	✓	✓	0 - 100 %	
2	INPUT VOLTAGE L2	✓	✓	0 - 100 %	
3	INPUT VOLTAGE L3	✓	✓	0 - 100 %	
4	INPUT CURRENT IL1	✓	✓	0 - 100 %	
5	INPUT CURRENT IL2	✓	✓	0 - 100 %	
6	INPUT CURRENT IL3	✓	✓	0 - 100 %	
7	ACTIVE POWER L1	✓	✗	0 - 120 %	



Parameter No.	Parameter	3P 4W	3P 3W	Range	
				Analog Output	
8	ACTIVE POWER L2	✓	✗	0 - 120 %	
9	ACTIVE POWER L3	✓	✗	0 - 120 %	
10	APPARENT POWER L1	✓	✗	0 - 120 %	
11	APPARENT POWER L2	✓	✗	0 - 120 %	
12	APPARENT POWER L3	✓	✗	0 - 120 %	
13	REACTIVE POWER L1	✓	✗	0 - 120 %	
14	REACTIVE POWER L2	✓	✗	0 - 120 %	
15	REACTIVE POWER L3	✓	✗	0 - 120 %	
16	POWER FACTOR L1	✓	✗	180 <sup>0</sup> / 0 / -180 <sup>0</sup>	
17	POWER FACTOR L2	✓	✗	180 <sup>0</sup> / 0 / -180 <sup>0</sup>	
18	POWER FACTOR L3	✓	✗	180 <sup>0</sup> / 0 / -180 <sup>0</sup>	
19	PHASE ANGLE L1	✓	✗	180 <sup>0</sup> / 0 / -180 <sup>0</sup>	
20	PHASE ANGLE L2	✓	✗	180 <sup>0</sup> / 0 / -180 <sup>0</sup>	
21	PHASE ANGLE L3	✓	✗	180 <sup>0</sup> / 0 / -180 <sup>0</sup>	
22	VOLTAGE AVG	✓	✓	0 - 100 %	
24	CURRENT AVG	✓	✓	0 - 100 %	
27	ACTIVE POWER SUM	✓	✓	0 - 120 %	
29	APPARENT POWER SUM	✓	✓	0 - 120 %	
31	REACTIVE POWER SUM	✓	✓	0 - 120 %	
32	POWER FACTOR AVG	✓	✓	180 <sup>0</sup> / 0 / -180 <sup>0</sup>	
34	PHASE ANGLE AVG	✓	✓	180 <sup>0</sup> / 0 / -180 <sup>0</sup>	
36	FREQUENCY	✓	✓	45 to 66 Hz	
43	WATT DEMAND IMPORT	✓	✓	0 - 120 %	
44	WATT MAX DEMAND IMP.	✓	✓	0 - 120 %	
45	WATT DEMAND EXPORT	✓	✓	0 - 120 %	
46	WATT MAX DEMAND EXP.	✓	✓	0 - 120 %	

Parameter No.	Parameter	3P 4W	3P 3W	Range	
				Analog Output	
51	VA DEMAND	✓	✓	0 - 120 %	
52	VA MAX DEMAND	✓	✓	0 - 120 %	
53	CURRENT DEMAND	✓	✓	0 - 100 %	
54	CURRENT MAX DEMAND	✓	✓	0 - 100 %	
101	INPUT VOLTAGE L12	✓	✗	0 - 100 %	
102	INPUT VOLTAGE L23	✓	✗	0 - 100 %	
103	INPUT VOLTAGE L31	✓	✗	0 - 100 %	
113	NEUTRAL CURRENT	✓	✗	0 - 100 %	

Note : Parameters 1,2,3 are L-N Voltage for 3P 4W & L-L Voltage for 3P 3W .

## 11. RS 485 ( ModBus ) Output :

This instrument supports MODBUS (RS485) RTU protocol ( 2-wire ).

Connection should be made using twisted pair shielded cable. All "A" and "B" connections are daisy chained together. The screens should also be connected to the "Gnd" terminal. To avoid the possibility of loop currents, an Earth connection should be made at one point on the network. Loop (ring) topology does not require any termination load. Line topology may or may not require terminating loads depending on the type and length of cable used. The impedance of the termination load should match the impedance of the cable and be at both ends of the line. The cable should be terminated at each end with a 120 ohm (1/4 Watt min.) resistor.

RS 485 network supports maximum length of 1.2km. Including the Master, a maximum of 32 instruments can be connected in RS 485 network. The permissible address range for the instrument is between 1 and 247 for 32 instruments. Broadcast Mode (address 0) is not allowed.

The maximum latency time for the instrument is 200ms i.e. this is the amount of time that can pass before the first response character is output.

After sending any query through software ( of the Master ) , it must allow 200ms of time to elapse before assuming that the instrument is not going to respond. If slave does not respond within 200 ms, Master can ignore the previous query and can issue fresh query to the slave.

The each byte in RTU mode has following format:

	8-bit binary, hexadecimal 0-9, A-F 2 hexadecimal characters contained in each 8-bit field of the message
<b>Format of Data Bytes</b>	4 bytes (32 bits) per parameter. Floating point format ( to IEEE 754 ) Most significant byte first (Alternative least significant first)
<b>Error Checking Bytes</b>	2 byte Cyclical Redundancy Check (CRC)
<b>Byte format</b>	1 start bit, 8 data bits, least significant bit sent first 1 bit for even/odd parity 1 stop bit if parity is used; 1 or 2 bits if no parity

Communication Baud Rate is user selectable from the front panel between 2400, 4800, 9600, 19200 bps.

**Function code :**

03	Read Holding Registers	Read content of read /write location ( 4X )
04	Read input Registers	Read content of read only location ( 3X )
16	Presets Multiple Registers	Set the content of read / write locations ( 4X )

**Exception Cases :** An exception code will be generated when the instrument receives ModBus query with valid parity & error check but which contains some other error ( e.g. Attempt to set floating point variable to an invalid value ) The response generated will be "Function code" Ored with HEX (80H). The exception codes are listed below

01	Illegal function	This function code is not supported by the instrument.
02	Illegal Data Address	Attempt to access an invalid address or an attempt to read or write part of a floating point value
03	Illegal Data Value	Attempt to set a floating point variable to an invalid value

### Accessing 3 X register for reading measured values:

Two consecutive 16 bit registers represent one parameter. Refer table 4 for the addresses of 3X registers (Parameters measured by the instruments).

Each parameter is held in the 3X registers. Modbus Code 04 is used to access all parameters.

#### Example :

To read parameter ,

Volts 3 : Start address= 04 (Hex)      Number of registers = 02

**Note : Number of registers = Number of parameters x 2**

Each Query for reading the data must be restricted to 20 parameters or less. Exceeding the 20 parameter limit will cause a ModBus exception code to be returned.

#### Query :

01 (Hex)	04 (Hex)	00 (Hex)	04 (Hex)	00 (Hex)	02 (Hex)	30 (Hex)	0A (Hex)
Device Address	Function Code	Start Address High	Start Address Low	Number of Registers Hi	Number of Registers Lo	CRC Low	CRC High

Start Address High : Most significant 8 bits of starting address of the parameter requested.

Start Address low : Least significant 8 bits of starting address of the parameter requested.

Number of register Hi : Most significant 8 bits of Number of registers requested.

Number of register Lo : Least significant 8 bits of Number of registers requested.

**(Note : Two consecutive 16 bit register represent one parameter.)**

**Response: Volt3 (219.25V)**

01 (Hex)	04 (Hex)	04 (Hex)	43 (Hex)	5B (Hex)	41 (Hex)	21 (Hex)	6F (Hex)	9B (Hex)
Device Address	Function Code	Byte Count	Data Register 1 High Byte	Data Register 1 Low Byte	Data Register 2 High Byte	Data Register 2 Low Byte	CRC Low	CRC High

Byte Count : Total number of data bytes received.

Data register 1 High Byte : Most significant 8 bit of Data register 1 of the parameter requested.

Data register 1 Low Byte : Least significant 8 bit of Data register 1 of the parameter requested.

Data register 2 High Byte : Most significant 8 bits of Data register 2 of the parameter requested.

Data register 2 Low Byte : Least significant 8 bits of Data register 2 of the parameter requested.

**(Note : Two consecutive 16 bit register represent on parameter.)**

**Table 4 : 3 X register addresses (measured parameters)**

Address (Register)	Parameter No.	Parameter	Modbus Start	Address Hex	3P 4W	3P 3W
			High Byte	Low Byte		
30001	1	Volts 1	00	0	✓	✓
30003	2	Volts 2	00	2	✓	✓
30005	3	Volts 3	00	4	✓	✓
30007	4	Current 1	00	6	✓	✓
30009	5	Current 2	00	8	✓	✓
30011	6	Current 3	00	A	✓	✓
30013	7	W1	00	C	✓	✗

Address (Register)	Parameter No.	Parameter	Modbus start	Address Hex	3P 4W	3P 3W
			High Byte	Low Byte		
30015	8	W2	00	E	✓	✗
30017	9	W3	00	10	✓	✗
30019	10	VA1	00	12	✓	✗
30021	11	VA2	00	14	✓	✗
30023	12	VA3	00	16	✓	✗
30025	13	VAR1	00	18	✓	✗
30027	14	VAR2	00	1A	✓	✗
30029	15	VAR3	00	1C	✓	✗
30031	16	PF1	00	1E	✓	✗
30033	17	PF2	00	20	✓	✗
30035	18	PF3	00	22	✓	✗
30037	19	Phase Angle 1	00	24	✓	✗
30039	20	Phase Angle 2	00	26	✓	✗
30041	21	Phase Angle 3	00	28	✓	✗
30043	22	Volts Ave	00	2A	✓	✓
30045	23	Volts Sum	00	2C	✓	✓
30047	24	Current Ave	00	2E	✓	✓
30049	25	Current Sum	00	30	✓	✓
30051	26	Watts Ave	00	32	✓	✓
30053	27	Watts Sum	00	34	✓	✓
30055	28	VA Ave	00	36	✓	✓
30057	29	VA Sum	00	38	✓	✓
30059	30	VAr Ave	00	3A	✓	✓
30061	31	VAr Sum	00	3C	✓	✓
30063	32	PF Ave	00	3E	✓	✓

Address (Register)	Parameter No.	Parameter	Modbus Start	Address Hex	3P 4W	3P 3W
			High Byte	Low Byte		
30065	33	PF Sum	00	40	✓	✗
30067	34	Phase Angle Ave	00	42	✓	✓
30069	35	Phase Angle Sum	00	44	✓	✗
30071	36	Freq	00	46	✓	✓
30073	37	Wh Import	00	48	✓	✓
30075	38	Wh Export	00	4A	✓	✓
30077	39	VARh Import	00	4C	✓	✓
30079	40	VARh Export	00	4E	✓	✓
30081	41	VAh	00	50	✓	✓
30083	42	Ah	00	52	✓	✓
30085	43	W Demand (Import)	00	54	✓	✓
30087	44	W Max Demand (Import)	00	56	✓	✓
30089	45	W Demand (Export)	00	58	✓	✓
30091	46	W Max Demand (Export)	00	5A	✓	✓
30093	47	-	-	-	-	-
30095	48	-	-	-	-	-
30097	49	-	-	-	-	-
30099	50	-	00	-	-	-
30101	51	VA Demand	00	64	✓	✓
30103	52	VA Max Demand	00	66	✓	✓
30105	53	A Demand	00	68	✓	✓
30107	54	A Max Demand	00	6A	✓	✓
30133	67	Volts Ave Max	00	84	✓	✓
30135	68	Volts Ave Min	00	86	✓	✓
30141	71	Current Ave Max	00	8C	✓	✓
30143	72	Current Ave Min	00	8E	✓	✓
30201	101	VL1-2 (Calculated)	00	C8	✓	✗



Address (Register)	Parameter No.	Parameter	Modbus start	Address Hex	3P 4W	3P 3W
			High Byte	Low Byte		
30203	102	VL 2 - 3 ( Calculated)	00	CA	✓	✗
30205	103	VL 3 - 1 ( Calculated)	00	CC	✓	✗
30207	104	V1 THD( % )	00	CE	✓	✓
30209	105	V2 THD( % )	00	D0	✓	✓
30211	106	V3 THD( % )	00	D2	✓	✓
30213	107	I1 THD( % )	00	D4	✓	✓
30215	108	I2 THD( % )	00	D6	✓	✓
30217	109	I3 THD( % )	00	D8	✓	✓
30219	110	System Voltage THD( % )	00	DA	✓	✓
30221	111	System Current THD( % )	00	DC	✓	✓
30225	113	I neutral	00	E0	✓	✗
30227	114	Run Hour	00	E2	✓	✓
30229	115	On Hour	00	E4	✓	✓
30231	116	No. Of Interrupts	00	E6	✓	✓

Note : Parameters 1,2,3 are L-N Voltage for 3P 4W & L-L Voltage for 3P 3W.

### Accessing 4 X register for Reading & Writing :

Each setting is held in the 4X registers. ModBus code 03 is used to read the current setting and code 16 is used to write/change the setting. Refer Table 5 for 4 X Register addresses.

#### Example : Reading System type

System type : Start address= 0A (Hex)      Number of registers = 02

Note : Number of registers = Number of Parameters x 2

Query :

Device Address	01 (Hex)
Function Code	03 (Hex)
Start Address High	00 (Hex)
Start Address Low	0A (Hex)
Number of Registers Hi	00 (Hex)
Number of Registers Lo	02 (Hex)
CRC Low	E4 (Hex)
CRC High	09 (Hex)

Start Address High : Most significant 8 bits of starting address of the parameter requested.

Start Address low : Least significant 8 bits of starting address of the parameter requested.

Number of register Hi : Most significant 8 bits of Number of registers requested.

Number of register Lo : Least significant 8 bits of Number of registers requested.

**(Note : Two consecutive 16 bit register represent one parameter.)**

**Response : System Type ( 3 phase 4 wire = 3 )**

Device Address	01 (Hex)
Function Code	03 (Hex)
Byte Count	04 (Hex)
Data Register1 High Byte	40 (Hex)
Data Register1 Low Byte	40 (Hex)

Data Register2 High Byte	00 (Hex)
Data Register2 Low Byte	00 (Hex)
CRC Low	EE (Hex)
CRC High	27 (Hex)

Byte Count : Total number of data bytes received.

Data register 1 High Byte : Most significant 8 bits of Data register 1 of the parameter requested.

Data register 1 Low Byte : Least significant 8 bits of Data register 1 of the parameter requested.

Data register 2 High Byte : Most significant 8 bits of Data register 2 of the parameter requested.

Data register 2 Low Byte : Least significant 8 bits of Data register 2 of the parameter requested.

**(Note : Two consecutive 16 bit register represent one parameter.)**

### **Example : Writing System type**

System type : Start address= 0A (Hex)      Number of registers = 02

**Query : ( Change System type to 3phase 3wire = 2 )**

Device Address	01 (Hex)
Function Code	10 (Hex)
Starting Address Hi	00 (Hex)
Starting Address Lo	0A (Hex)
Number of Registers Hi	00 (Hex)
Number of Registers Hi	02 (Hex)

Byte Count	04 (Hex)
Data Register-1 High Byte	40 (Hex)
Data Register-1 Low Byte	00 (Hex)
Data Register-2 High Byte	00 (Hex)
Data Register-2 Low Byte	00 (Hex)
CRC Low	60 (Hex)
CRC High	10 (Hex)

Byte Count : Total number of data bytes received.

Data register 1 High Byte : Most significant 8 bits of Data register 1 of the parameter requested.

Data register 1 Low Byte : Least significant 8 bits of Data register 1 of the parameter requested.

Data register 2 High Byte : Most significant 8 bits of Data register 2 of the parameter requested.

Data register 2 Low Byte : Least significant 8 bits of Data register 2 of the parameter requested.

**(Note : Two consecutive 16 bit register represent one parameter.)**

**Response:**

Device Address	01 (Hex)
Function Code	10 (Hex)
Start Address High	00 (Hex)
Start Address Low	0A (Hex)
Number of Registers Hi	00 (Hex)
Number of Registers Lo	02 (Hex)
CRC Low	61 (Hex)
CRC High	CA (Hex)

Start Address High : Most significant 8 bits of starting address of the parameter requested.

Start Address low : Least significant 8 bits of starting address of the parameter requested.

Number of register Hi : Most significant 8 bits of Number of registers requested.

Number of register Lo : Least significant 8 bits of Number of registers requested.

**(Note : Two consecutive 16 bit register represent one parameter.)**

**Table 5 : 4 X register addresses**

Address (Register)	Parameter No.	Parameter	Read / Write	Modbus Start Address Hex	
				High Byte	Low Byte
40001	1	Demand Reset	R/Wp	00	00
40003	2	Demand Period	R/Wp	00	02
40005	3	Energy on RS485	R/Wp	00	04
40007	4	Sys Voltage	R	00	06
40009	5	Sys Current	R	00	08
40011	6	Sys Type	R/Wp	00	0A
40015	8	Energy Reset	Wp	00	0E
40017	9	Run/On Hour & Interruption Reset	Wp	00	10
40019	10	RS 485 Set-up Code	R/Wp	00	12
40021	11	Node Address.	R/Wp	00	14
40025	13	Min Reset	Wp	00	18
40027	14	Max Reset	Wp	00	1A
40029	15	Analog Out 1- Para Sel	R/Wp	00	1C
40031	16	Analog Out 2- Para Sel	R/Wp	00	1E
40033	17	PT Primary	R/Wp	00	20
40035	18	CT Primary	R/Wp	00	22

Address (Register)	Parameter No.	Parameter	Read / Write	Modbus Start Address Hex	
				High Byte	Low Byte
40037	19	System Power	R	00	24
40039	20	Energy digit reset count	R/Wp	00	26
40041	21	Register Order/Word Order	R/Wp	00	28
40043	22	CT Secondary	R/Wp	00	2A
40045	23	PT Secondary	R/Wp	00	2C
40071	36	Password	R/W	00	46
40079	40	30mA Noise Current Elimination	R/Wp	00	4E

## Explanation for 4 X register :

Address	Parameter	Description
40001	Demand Reset	Demand Reset is used to reset the Demand parameter. A value of zero must be Written to this register to reset the Demand period. Writing any other value will return an error.
40003	Demand Period	Demand period represents demand time in minutes. The applicable value are 8,15,20 or 30. Writing any other value will return an error.
40005	Energy display on Modbus	This address is used to set energy display on MODBUS in Wh, KWh & Mwh. Write one of the following value to this address. 1 = Energy in Wh.                      2 = Energy in KWh. 3 = Energy in MWh.
40007	System Voltage	This address is read only and displays System Voltage
40009	System Current	This address is read only and display System Current
40011	System Type	This address is used to set the System type. Write one of the follow value to this address. 2 = 3 Phase 3 Wire 3 = 3 Phase 4 Wire. Writing any other value will return error.
40015	Reset Energy Counter	This address is used to reset the Energy Counter. Write zero value to this register to reset the energy counter. Writing any other value will return an error.

Address	Parameter	Description
40017	Run/On Hour & Interruption reset	This address is used to reset the Run/ON hour & number of Interruption. Write zero value to this register to reset the Run/On hour & number of Interruption. Writing any other value will return an error.
40019	Rs485 Set-up Code	This address is used to set the baud rate, Parity, Number of stop bits. Refer to Table 6 for details.
40021	Node Address	This register address is used to set Device address between 1 to 247.
40025	Min - Reset	This address is used to reset the Min parameters value. Write Zero value to this register to reset the Min parameters. Writing any other value will return an error.
40027	Max - Reset	This address is used reset the Max parameters value. Write Zero value to this register to reset the Max parameters. Writing any other value will return an error.
40029	Analog Out 1-Para Set	This address is used to set the parameter for Analog Output 1. Write one of the parameter no. As per the options given in Table 2 for Analog Output Parameters.



Address	Parameter	Description
40031	Analog Out 2-Para Set	This address is used to set the parameter for Analog Output 2. Write one of the parameter no. AS per the option given in Table 2 for Analog Output Parameters.
40033	PT Primary	This address allows the user to set PT Primary value. The maximum settable value is 692.8kV L-L depends on the phase 666.6MVA Restriction of power combined with CT primary.
40035	CT Primary	This address allows the user to set CT Primary Value. The maximum settable value is 9999 & also depends on the per phase 666.6MVA Restriction of power combined with PT primary.
40037	Sys Power	System Power (Read Only) is the Nominal system power base on the values of Nominal system volts and Nominal system current.
40039	Energy digit Reset Count	This address is used to set the rollover count for energy. If Energy on Rs485 is in Wh rollover count can be from 7 to 14. If it is in KWh then rollover count can be from 7 to 12 & for MWh rollover count can be from 7 to 9.
40041	Word Order	Word Order controls the order in which the instrument receives or sends floating - point numbers:- normal or reversed register order. In normal mode, the two registers that make up a floating point numbers are sent most significant bytes first. In reversed register mode, the two registers that make up a floating point numbers are sent least significant bytes first. To set mode, write the value '2141.0' into this register- the instrument will detect the order used to send this value and set that order for all ModBus transaction involving floating point numbers.

Address	Parameter	Description
40043	CT secondary	This address is used to read and write the CT secondary value write one of the following values this address. 1=1A CT secondary 5=5A CT secondary writing any other value will return an error.
40045	PT secondary	This address is used to read and write the PT secondary value. Ref Table for the range of PT secondary settable value in Section 3.2.1.3
40071	Password	This address is used to set & reset the password. Valid Range of Password can be set is 0000 - 9999. 1) If password lock is present & if this location is read it will return <b>zero</b> . 2) If Password lock is absent & if this location is read it will return <b>One</b> . 3) If password lock is present & to disable this lock first send valid password to this location then write "0000" to this location. 4) If password lock is present & to modify 4X parameter first send valid password to this location so that 4X parameter will be accessible for modification. 5) If for in any of the above case invalid password is sent then meter will return exceptional error 2.
40079	30mA Noise current Elimination	This address is used to activate or de-activate the 30 mA noise current elimination write 0-Deactivate 30 (Decimal)-Activate Writing any other value will return an error.

**Table 6 : RS 485 Set-up Code**

Baud Rate	Parity	Stop Bit	Decimal value
19200	NONE	01	12
19200	NONE	02	13
19200	EVEN	01	14

Baud Rate	Parity	Stop Bit	Decimal value
19200	ODD	01	15
9600	NONE	01	08
9600	NONE	02	09
9600	EVEN	01	10
9600	ODD	01	11
4800	NONE	01	04
4800	NONE	02	05
4800	EVEN	01	06
4800	ODD	01	07
2400	NONE	01	00
2400	NONE	02	01
2400	EVEN	01	02
2400	ODD	01	03

**NOTE :**

Codes not listed in the table above may give rise to unpredictable results including loss of communication. Excise caution when attempting to change mode via direct Modbus writes.

This instrument contains the 20 user assignable registers in the address range of 0x200 (30513) to 0x226 (30551) (see **Table 9**).

Any of the parameter addresses ( 3X register addresses Table 4)) accessible in the instrument can be mapped to these 20 user assignable registers.

Parameters (3X registers addresses ) that resides in different locations may be accessed by the single request by re-mapping them to adjacent address in the user assignable registers area.

The actual address of the parameters ( 3X registers addresses) which are to be assessed via address 0x200 to 0x226 are specified in 4x Register 0x200 to 0x213 (see **Table 10**).

**Table 9 : User Assignable 3X Data Registers**

Address (Register)	Parameter Number.	Assignable Register	Modbus Start Address (Hex)	
			High Byte	Low Byte
30513	257	Assignable Reg 1	02	00
30515	258	Assignable Reg 2	02	02
30517	259	Assignable Reg 3	02	04
30519	260	Assignable Reg 4	02	06
30521	261	Assignable Reg 5	02	08
30523	262	Assignable Reg 6	02	0A

Address (Register)	Parameter Number.	Assignable Register	Modbus Start Address (Hex)	
			High Byte	Low Byte
30525	263	Assignable Reg 7	02	0C
30527	264	Assignable Reg 8	02	0E
30529	265	Assignable Reg 9	02	10
30531	266	Assignable Reg 10	02	12
30533	267	Assignable Reg 11	02	14
30535	268	Assignable Reg 12	02	16
30537	269	Assignable Reg 13	02	18
30539	270	Assignable Reg 14	02	1A
30541	271	Assignable Reg 15	02	1C
30543	272	Assignable Reg 16	02	1E
30545	273	Assignable Reg 17	02	20
30547	274	Assignable Reg 18	02	22
30549	275	Assignable Reg 19	02	24
30551	276	Assignable Reg 20	02	26

**Table 10 : User Assignable mapping register ( 4X registers)**

Address (Register)	Parameter Number.	Mapping Register	Modbus Start Address (Hex)	
			High Byte	Low Byte
40513	257	Mapped Add for register #0x0200	02	00
40514	258	Mapped Add for register #0x0202	02	01
40515	259	Mapped Add for register #0x0204	02	02
40516	260	Mapped Add for register #0x0206	02	03
40517	261	Mapped Add for register #0x0208	02	04
40518	262	Mapped Add for register #0x020A	02	05
40519	263	Mapped Add for register #0x020C	02	06
40520	264	Mapped Add for register #0x020E	02	07

Address (Register)	Parameter Number.	Mapped Register	Modbus start Address (Hex)	
			High Byte	Low Byte
40521	265	Mapped Add for register #0x0210	02	08
40522	266	Mapped Add for register #0x0212	02	09
40523	267	Mapped Add for register #0x0214	02	0A
40524	268	Mapped Add for register #0x0216	02	0B
40525	269	Mapped Add for register #0x0218	02	0C
40526	270	Mapped Add for register #0x021A	02	0D
40527	271	Mapped Add for register #0x021C	02	0E
40528	272	Mapped Add for register #0x021E	02	0F
40529	273	Mapped Add for register #0x0220	02	10
40530	274	Mapped Add for register #0x0222	02	11
40531	275	Mapped Add for register #0x0224	02	12
40532	276	Mapped Add for register #0x0226	02	13

### Example :

#### Assigning parameter to user assignable registers

To access the voltage2 (3X address 0x0002) and Power Factor1 (3X address 0x001E) through user assignable register assign these addresses to 4x register (Table 10 ) 0x0200 and 0x0201 respectively.

#### Assigning Query:

Device Address	01 (Hex)
Function Code	10 (Hex)
Starting Address Hi	02 (Hex)
Starting Address Lo	00 (Hex)
Number of Register Hi	00 (Hex)*
Number of Register Lo	02 (Hex)*

Byte Count	04 (Hex)
Data Register-1 High Byte	00 (Hex)
Data Register-1 Low Byte	02 (Hex)
Data Register-2 High Byte	00 (Hex)
Data Register-2 Low Byte	1E (Hex)
CRC Low	CB (Hex)
CRC High	07 (Hex)

} Voltage 2 \*  
(3X Address 0x0002)

} Power Factor 1 \*  
(3X Address 0x001E)

### Response :

Device Address	01 (Hex)
Function Code	10 (Hex)
Start Address High	02 (Hex)
Start Address Low	00 (Hex)
Number of Register Hi	00 (Hex)
Number of Register Lo	02 (Hex)
CRC Low	40 (Hex)
CRC High	70 (Hex)

### Reading Parameter data through User Assignable Registers:

In assigning query Voltage2 and Power Factor1 parameters were assigned to 0x200 and 0x201(Table10) which will point to user assignable 3x registers 0x200 and 0x202 (Table 9). So to read Voltage2 and Power Factor1 data reading query should be as below.

**Query:**

Device Address	01 (Hex)
Function Code	04 (Hex)
Start Address High	02 (Hex)
Start Address Low	00 (Hex)
Number of Registers Hi	00 (Hex)
Number of Registers Lo	04 (Hex) **
CRC Low	F0 (Hex)
CRC High	71 (Hex)

Start Address High : Most significant 8 bits of starting address of User assignable register.

Start Address low : Least significant 8 bits of starting address of User assignable register.

Number of register Hi : Most significant 8 bits of Number of registers requested.

Number of register Lo : Least significant 8 bits of Number of registers requested.

**\*\*Note : Two consecutive 16 bit register represent one parameter.**

**Since two parameters are requested four registers are required**

Response : (Volt2 = 219.30 / Power Factor1 = 1.0)

Device Address	01 (Hex)
Function Code	04 (Hex)
Byte count	08 (Hex)
Data Register-1 High Byte	43 (Hex)
Data Register-1 Low Byte	5B (Hex)
Data Register-2 High Byte	4E (Hex)
Data Register-2 Low Byte	04 (Hex)

} Voltage 2 Data



Data Register-3 High Byte	3F (Hex)	} Power Factor 1 Data
Data Register-3 Low Byte	80 (Hex)	
Data Register-4 High Byte	00 (Hex)	
Data Register-4 Low Byte	00 (Hex)	
CRC Low	79 (Hex)	
CRC High	3F (Hex)	

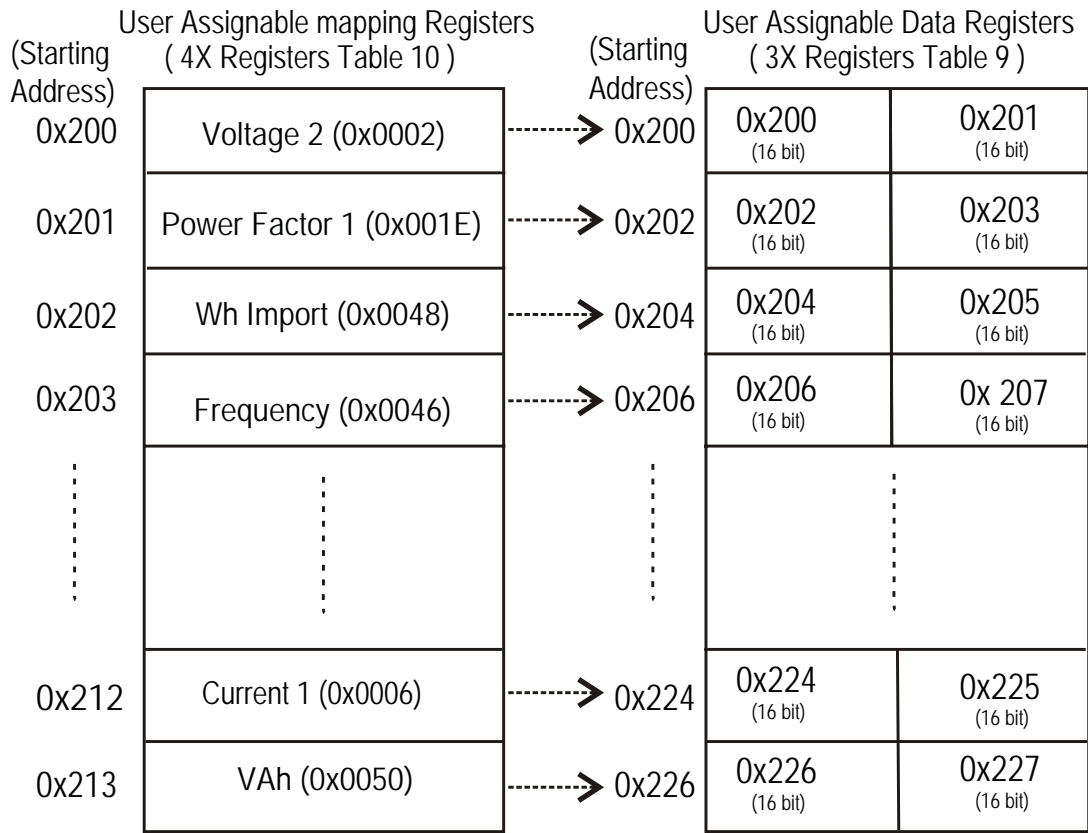

**To get the data through User assignable Register use following step:**

- 1) Assign starting addresses (Table 3) of parameters of interest to a "User assignable mapping registers" in a sequence in which they are to be accessed (see section "Assigning parameter to user assignable registers")
- 2) Once the parameters are mapped data can be acquired by using "User assignable data register" Starting address . i.e to access data of Voltage2, Power factor1, Wh import, Frequency send query with starting address 0x200 with number of register 8 or individually parameters can be accessed for example if current1 to be accessed use starting address 0x212. (See section Reading Parameter data through User Assignable Registers)

**12. Phaser Diagram :**

**Quadrant 1:** 0° to 90°  
**Quadrant 2:** 90° to 180°

**Quadrant 3:** 180° to 270°  
**Quadrant 4:** 270° to 360°

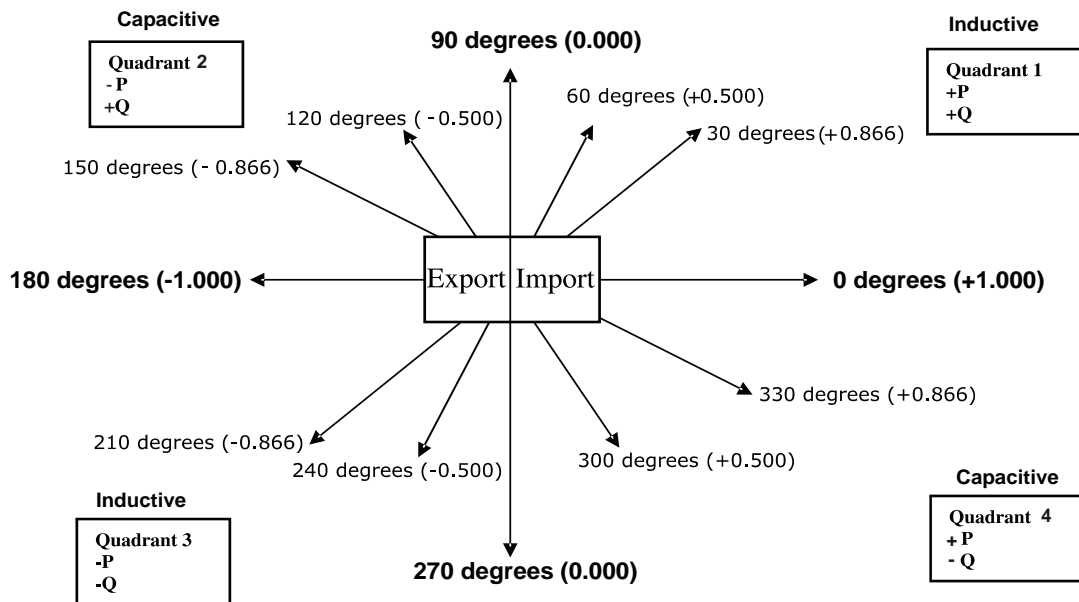

Connections	Quadrant	Sign of Active Power ( P )	Sign of Reactive Power ( Q )	Sign of Power Factor ( PF )	Inductive / Capacitive
Import	1	+ P	+ Q	+	L
Import	4	+ P	- Q	+	C
Export	2	- P	+ Q	-	C
Export	3	- P	- Q	-	L

Inductive means Current lags Voltage  
 Capacitive means Current leads Voltage

When the instrument displays Active power ( P )with “ + ” ( positive sign ) ,  
 the connection is “ **Import** ”.

When the instrument displays Active power ( P )with “ - ” ( negative sign ) ,  
 the connection is “ **Export** ”.

### 13. Installation

Mounting is by four side clamps, slide the side clamps through side slot till side clamp gets firmly locked in a groove (Refer fig.) Consideration should be given to the space required behind the instrument to allow for bends in the connection cables.

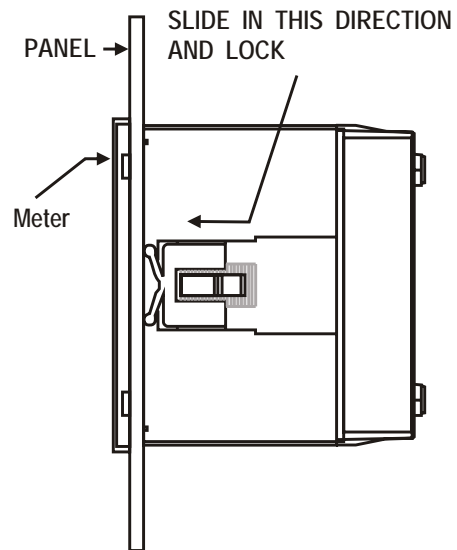

As the front of the enclosure conforms to IP54 it is protected from water spray from all directions, additional protection to the panel may be obtained by the use of an optional panel gasket. The terminals at the rear of the product should be protected from liquids.

The instrument should be mounted in a reasonably stable ambient temperature and where the operating temperature is within the range -20 to 70°C. Vibration should be kept to a minimum and the product should not be mounted where it will be subjected to excessive direct sunlight.

### Caution

- 1. In the interest of safety and functionality this product must be installed by a qualified engineer, abiding by any local regulations.**
- 2. Voltages dangerous to human life are present at some of the terminal connections of this unit. Ensure that all supplies are de-energised before attempting any connection or disconnection.**
- 3. These products do not have internal fuses therefore external fuses must be used to ensure safety under fault conditions.**

## 13.1 EMC Installation Requirements

This product has been designed to meet the certification of the EU directives when installed to a good code of practice for EMC in industrial environments, e.g,

1. Screened output and low signal input leads or have provision for fitting RF suppression components, such as ferrite absorbers, line filters ect., in the event that RF fields cause problems.

Note: it is good practice to install sensitive electronic instruments that are performing critical functions, in EMC enclosures that protect against electrical interference which could cause a disturbance in function.

2. Avoid routing leads alongside cables and products that are, or could be, a source of interference.

3. To protect the product against permanent damage, surge transients must be limited to 2kV pk. It is good EMC practice to suppress differential surges to 2kV at the source. The unit has been designed to automatically recover in the event of a high level of transients. In extreme circumstances it may be necessary to temporarily disconnect the auxiliary supply for a period of greater than 5 seconds to restore correct operation.  
  
The Current inputs of these products are designed for connection in to systems via Current Transformers only, where one side is grounded.
4. ESD precautions must be taken at all times when handling this product.

### 13.2 Case Dimension and Panel Cut Out

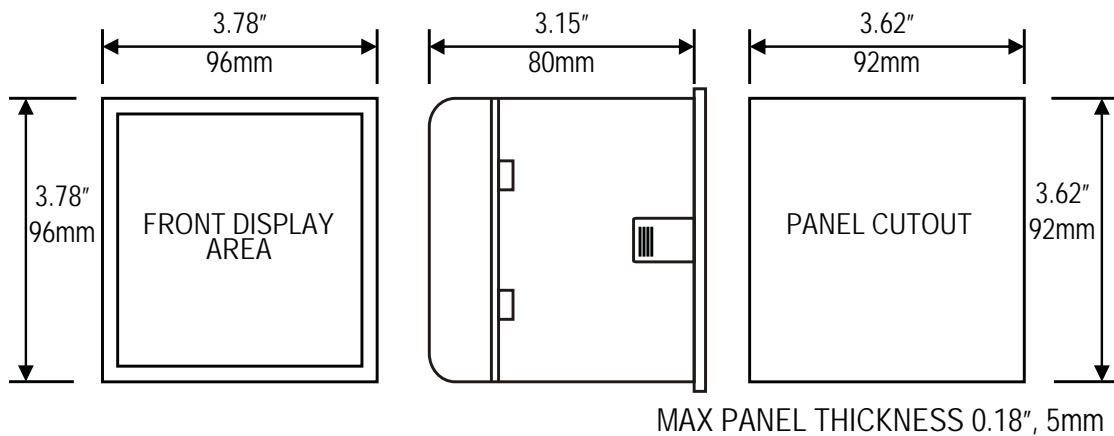

### 13.3 Wiring

Input connections are made directly to screw-type terminals with indirect wire pressure. Numbering is clearly marked in the plastic moulding. Choice of cable should meet local regulations. Terminal for both Current and Voltage inputs will accept up to 3mm<sup>2</sup> x 2 diameter cables.

**Note :** It is recommended to use wire with lug for connection with meter.

### 13.4 Auxiliary Supply

The instrument should ideally be powered from a dedicated supply, however it may be powered from the signal source, provided the source remains within the limits of the chosen auxiliary voltage.

### 13.5 Fusing

It is recommended that all voltage lines are fitted with 1 amp HRC fuses.

### 13.6 Earth/Ground Connections

For safety reasons, CT secondary connections should be grounded in accordance with local regulations.

## 14. Connection Diagrams

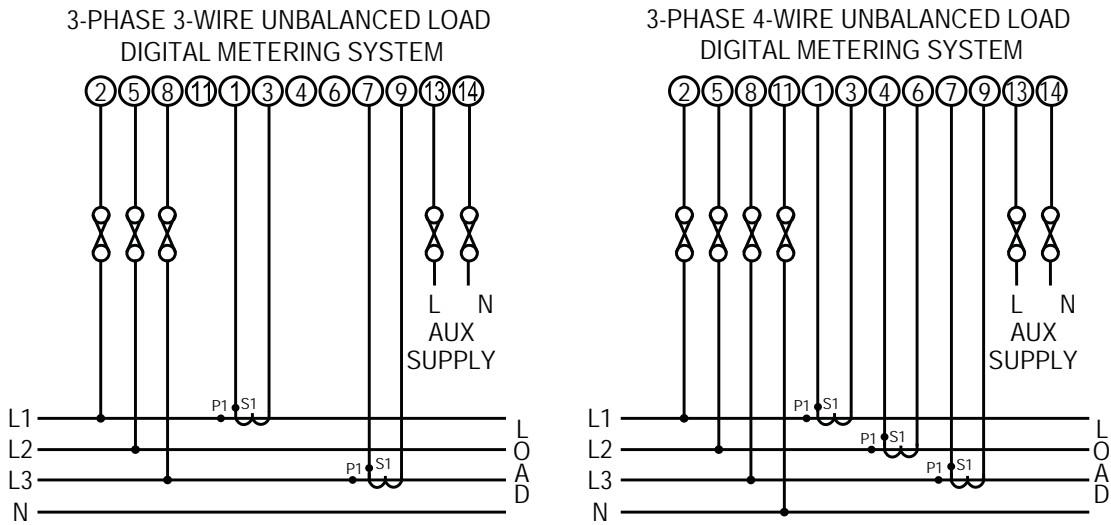

### 15. Specification : System

3 Phase 3 Wire / 4 Wire programmable at site

## Inputs

Nominal input voltage (AC RMS) (Three wire and Four wire)	Phase-Neutral 63.5 / 133 / 239.6 / 254 V <sub>L-N</sub> Line-Line 110 / 230 / 415 / 440 V <sub>L-L</sub>
Max continuous input voltage	120% of Rated Value
Max short duration input voltage	2 x Rated Value (1s application repeated 10 times at 10s intervals)
Nominal input voltage burden	0.2VA approx. per phase
Nominal input current	5A AC rms
Max continuous input current	120% of Rated Value
Nominal input current burden	0.6VA approx. per phase
Max short duration current input	20 x Rated Value (1s application repeated 5 times at 5 min. intervals)
System CT primary values	Std. Values from 1 to 9999A (1 or 5 Amp secondaries)

## Auxiliary

Standard nominal Auxillary supply voltages & Frequency	100 - 250VAC- DC (45-66Hz), 12 - 48V DC
a.c. supply voltage tolerance	+10 % / -10 % of Rated Value
d.c. supply voltage tolerance	+10 % / -10 % of Rated Value
a.c. supply frequency range	45 to 66 Hz
a.c. supply burden	6.5 V A
d.c. supply burden	3W

## Operating Measuring Ranges

Voltage	5 .. 120 % of Rated Value
Current	5 .. 120 % of Rated Value
Frequency	40 .. 70 Hz
Power Factor	0.5 Lag ... 1 ... 0.8 Lead

## Accuracy

### Accuracy 1:

Voltage	± 0.5 % of range
Current	± 0.5 % of range
Frequency	0.15% of mid frequency
Active Power	± 0.5 % of range
Re- Active Power	± 0.5 % of range
Apparent Power	± 0.5 % of range
Active Energy	± 1.0 % of range
Re -Active Energy	± 1.0 % of range
Apparant Energy	± 1.0 % of range
Power Factor	± 1 % of Unity
Angle	± 1 % of range
Analog Output	± 1 % of Output end value
Total Harmonic Distortion	± 1 %
Neutral Current	± 4 % of range.

### Accuracy 0.5:

Voltage	± 0.5 % of range
Current	± 0.5 % of range
Frequency	0.15% of mid frequency
Active Power	± 0.5 % of range
Re- Active Power	± 0.5 % of range
Apparent Power	± 0.5 % of range
Active Energy	± 0.5 % of range



Re -Active Energy	± 0.5 % of range
Apparent Energy	± 0.5 % of range
Power Factor	± 1 % of Unity
Angle	± 1 % of range
Analog Output	± 1 % of Output end value
Total Harmonic Distortion	± 1 %
Neutral Current	± 4 % of range

### **Accuracy 0.2:**

Voltage	± 0.2 % of range
Current	± 0.2 % of range
Frequency	0.15 % of mid frequency
Active Power	± 0.2 % of range
Re- Active Power	± 0.2 % of range
Apparent Power	± 0.2 % of range
Active Energy	± 0.2 % of range
Re - Active Energy	± 0.2 % of range
Apparant Energy	± 0.2 % of range
Power Factor	± 1 % of Unity
Angle	± 1 % of range
Analog Output	± 1 % of Output end value
Total Harmonic Distortion	± 1 %
Neutral Current	± 4 % of range

### **Reference conditions for Accuracy :**

Reference temperature	23°C ± 2°C
Input frequency	50 or 60Hz ± 2%
Input waveform	Sinusoidal (distortion factor 0.005)
Auxiliary supply voltage	Rated Value ± 1%
Auxiliary supply frequency	Rated Value ± 1 %
Voltage Range	50... 100% of Nominal Value. 60... 100% of Nominal Value for THD.

Current Range	10... 100% of Nominal Value. 20... 100% of Nominal Value for THD.
Power	$\cos\theta / \sin\theta = 1$ For Active / Reactive Power & Energy 10... 100% of Nominal Current & 50... 100% of Nominal Voltage.
Power Factor / Phase Angle	40... 100% of Nominal Current & 50... 100% of Nominal Voltage.

### **Nominal range of use of influence quantities for measurands**

Voltage	50 .. 120 % of Rated Value
Current	10 .. 120 % of Rated Value
Input frequency	Rated Value $\pm$ 10 %
Temperature	-20 to 70°
Auxiliary supply voltage	Rated Value $\pm$ 10 %
Auxiliary supply frequency	Rated Value $\pm$ 10 %
Temperature Coefficient (For Rated value range of use 0... 50°C )	0.025% / °C for Voltage (50..120% of Rated Value) 0.05% / °C for Current (10..120% of Rated Value)
Error change due to variation of an influence quantity	2 * Error allowed for the reference condition applied in the test.

### **Display**

TFT LCD	3.5" Graphical LCD, resolution 320x240
Update	pixels Approx. 1 seconds

### **Controls**

User Interface	Resistive Touch screen
----------------	------------------------

## Standards

EMC Immunity

IEC 61326

10V/m min-Level 3 industrial low level  
electromagnetic radiation environment

IEC 61000-4-3.

Safety

IEC 61010-1 , Year 2001

IP for water & dust

IEC 60529

## Isolation

Dielectric voltage withstand  
test between circuits and  
accessible surfaces

2.2 kV RMS 50 Hz for 1 minute  
between all electrical circuits

## Environmental

Operating temperature

-20 to 70 °C

Storage temperature

-30 to +80 °C

Relative humidity

0 .. 90 % RH

Warm up time

3 minute (minimum)

Shock

15g in 3 planes

Vibration

10 .. 55 Hz, 0.15mm amplitude

Enclosure ( front only )

IP 54 as per IEC 60529

## Enclosure

Style

96mm x 96mm DIN Quadratic

Material

Polycarbonate Housing ,

Terminals

Self extinguish & non dripping as per UL94 V-0

Screw-type terminals

Depth

< 80 mm

Weight

0.620 kg Approx.

**ModBus ( RS 485 ) Option :**

Protocol

ModBus ( RS 485 )

Baud Rate

19200 , 9600 , 4800 or 2400  
( Programmable )

Parity

Odd or Even, with 1 stop bit,  
Or None with 1 or 2 stop bits

**Analog Output Option :**

Linear

4 ... 20mA dc into 0 - 500 ohm  
Uni-directional, internally powered.

## 16. Connection for Optional RS 485 / Analog Output ( rear view of the instrument )

### 1. RS 485 + Two Analog Output



## **WARRANTY**

Dear Sir,

You are now the privileged owner of Multi Function Meter / accessories, a product that rank the first of its kind in the world.

Company provides 36 months warranty from the original date of Purchase against defective material and workmanship.

In the unlikely event of failure of this meter / accessories within the warranty period, Company undertakes to get the meter / accessories repaired free of charge, Please handover the meter / accessories to the dealer / stockist from whom you have purchased along with this card and relevant Cash memo / Invoice. This warranty entitles you to bring the meter / accessories at your cost to the nearest stockist / dealer collect it after repairs.

### **NO TRANSPORTATION CHARGE WILL BE REIMBURSED**

The warranty is not valid in following cases:

- 1) Warranty card duly signed and stamped and original Cash memo/Invoice is not send along with meter / accessories.
- 2) Complete warranty card is not presented to authorized person at the time of repairs.
- 3) Meter / accessories is not used as per the instructions in the user manual.
- 4) Defect caused by misuse, negligence, accidents, tampering and Acts of God.
- 5) Improper repairing by any person not authorized by the company.
- 6) Any sort of Modification, Alteration is made in electrical circuitry.
- 7) Seal provided inside is broken.

In case of dispute to the validity of the warranty, the decision of services center will be final.

If you bought this meter / accessories directly fro the company, and if you notice transit damage, then you must obtain the insurance surveyor report and forward it.  
Thank you.

(To be filled by authorised dealer)

Model No. : \_\_\_\_\_  
Serial Number : \_\_\_\_\_  
Date of Purchase : \_\_\_\_\_  
Cash Memo / Invoice No. : \_\_\_\_\_  
Dealers Signature : \_\_\_\_\_  
Dealer Stamp : \_\_\_\_\_

**Scope of supply**

- 1) Side Clamp
- 2) Connecters
- 3) User Manual
- 4) Warranty Card
- \*5) Test Certificate

\*As per customer requirements



**Caution, risk of electric shock.**

**Attention, risque de choc électrique.**

---

The Information contained in these installation instructions is for use only by installers trained to make electrical power installations and is intended to describe the correct method of installation for this product. However, Company has no control over the field conditions which influence product installation.

It is the user's responsibility to determine the suitability of the installation method in the user's field conditions. Company only obligations are those in Company standard Conditions of Sale for this product and in no case will Company be liable for any other incidental, indirect or consequential damages arising from the use or misuse of the products.

---

*Simpson*

Simpson Electric Company  
520 Simpson Avenue  
Lac Du Flambeau, WI 54538-0099 (USA)  
Web: [www.simpsonelectric.com](http://www.simpsonelectric.com)  
Contact: +1 715-588-3311

---

**Manual Part No. 06-118318**  
**Edition 2, 05/18**